



CUTOUT DIMENSIONS

Hot Cold Dual Operation  
3 Well Drop In Slim Line  
Model #HCDO3DISL  
Item #C1002

Standard Features

- Independent infinite temperature controls for each well
- 1250 watt heat element per well
- Compressor located on left
- Each well accommodates one 12" x 20" pan or fractional equivalent
- 1" Flex 3' Long
- Main power in
- 1/2 HP condensing Unit
- Adjustable Feet
- Airflow inlet left exhaust front or back
- Locking Tabs
- One Pan Lifting Ring included per well
- Refrigerant 404A
- 208/220 Volt 1 Phase 30 Amp 4 Wire NEMA 14-30P

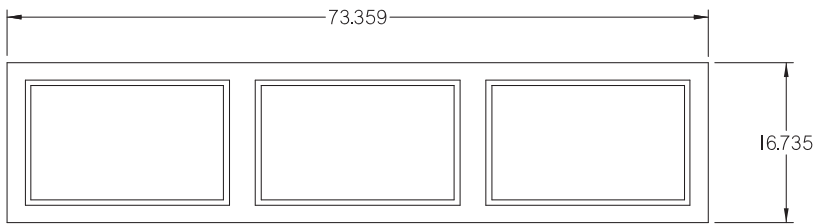

TOP VIEW

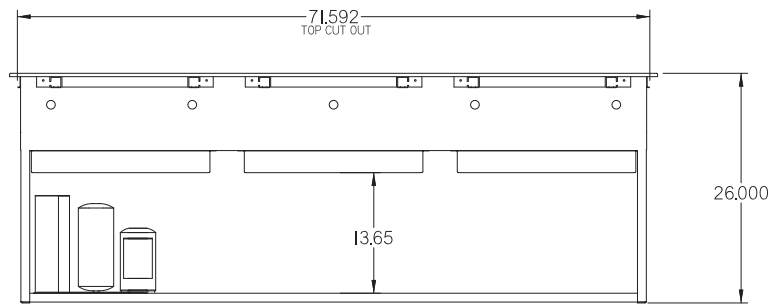

FRONT VIEW

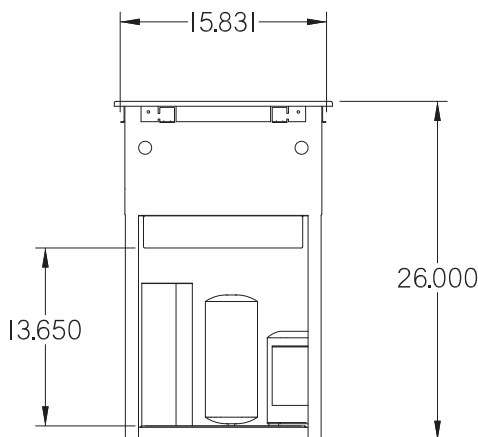

END VIEW

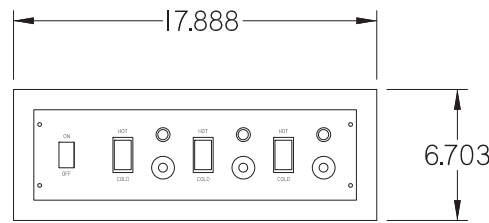

CONTROL PANEL

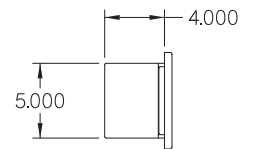

CONTROL PANEL SIDE VIEW

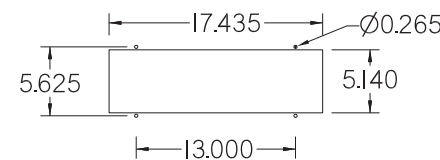

CONTROL PANEL CUTOUT



Conforms to UL Std. 197 & 471 & NSF/ANSI Std. 4 & 7

CONFIDENTIAL DESIGN - G.A. Systems, Inc. considers this new design proprietary and confidential. Due to the existing relationship of trust and good faith between G.A. Systems and Recipient. G.A. Systems is providing this proprietary and confidential design and related information to Recipient with the understanding that Recipient will maintain such design and information in secrecy and will not direct or indirectly use, disseminate, or otherwise disclose this proprietary and confidential information to any outside person or organization without the express written prior consent of G.A. Systems, Inc.

Rev 04/2019